

Lauren Hood, MCD
Chairperson
Donovan Smith
Vice Chair/Secretary

Marcell R. Todd, Jr.
Director

City of Detroit
CITY PLANNING COMMISSION
208 Coleman A. Young Municipal Center
Detroit, Michigan 48226
Phone: (313) 224-6225 Fax: (313) 224-4336
e-mail: cpc@detroitmi.gov

Brenda Goss Andrews
Kenneth R. Daniels
David Esparza, AIA, LEED
Ritchie Harrison
Gwen Lewis
Melanie Markowicz
Frederick E. Russell, Jr.

March 23, 2023

HONORABLE CITY COUNCIL

RE: Request of Mariners' Church of Detroit for PC (Public Center) Special District Review of proposed exterior alterations to 170 East Jefferson Avenue – Mariners' Church of Detroit
(RECOMMEND APPROVAL WITH CONDITIONS)

REQUEST

The City Planning Commission (CPC) has received a request from Thomas Roberts Architect on behalf of Mariners' Church for PC (Public Center) Special District Review of proposed exterior alterations to 170 East Jefferson Avenue – Mariners' Church of Detroit. This request is being made consistent with the provisions of Section 50-3-225 of the Zoning Ordinance. Section 50-3-225 states that whether or not site plan review is required for a project in the PC District, the exterior design, appearance, and location of exterior alterations shall be reviewed by the CPC and the Planning and Development Department (PDD) and require the authorization of Your Honorable Body.

Site Plan Review

In accordance with the provisions of Section 50-3-113, CPC staff finds that site plan review is not required based on the extent of proposed exterior modifications. Specifically, 50-3-113(5) does not apply as the Board of Zoning Appeals (BZA) is not "the body of first jurisdiction" for the PC District based on Section 50-3-225. Therefore, the CPC and the PDD shall review this request in accordance with Section 50-11-67 PC District review criteria.

BACKGROUND & PROPOSAL

From the Detroit Historical Society's Encyclopedia of Detroit:

Mariners' Church was established in 1842 with money willed by Julia Ann Anderson, the widow of Fort Detroit commander Colonel John Anderson. She specified that her lot on the corner of Woodward Avenue and Woodbridge Street in Detroit become "a site for a Mariners' Church..." specifically to watch over the spiritual well-being of sailors and the greater community. These sailors were often marginalized and treated as outsiders, so she also specified that it be a stone church, with "forever free" pews. Since sailors often could not afford pew rentals or give sufficient tithes to maintain the parish, the will stipulated that stores be designated for the ground floor to provide rental revenue. The plans and drawings of the "Perpendicular Gothic" building were made by C.N. Otis, a Buffalo, New York architect, and in 1849 the Gothic Revival stone structure was constructed on the site of Anderson's mansion. Scattered throughout the church are paintings, photographs and ship models that symbolize its maritime history. The various stained glass windows, by the J & R Lamb Studios, depict mariners and symbols of the Great Lakes. In 1955, Detroit's plans for a new civic center called for the demolition of the church. Instead, the 3000-ton building was moved 880 feet east to its current location. During the move, workers discovered a tunnel under the building from its days as a stop on the Underground Railroad. The Episcopal Church sought to

overturn Mariners' continuous legal independence free of denominational ties in the 1980s but was defeated twice. Mariners' has continuously served the community as a church in the Anglican tradition, governed independently.



1890's Image of Previous Location and Pinnacles – Twitter: @detroitstreetvu

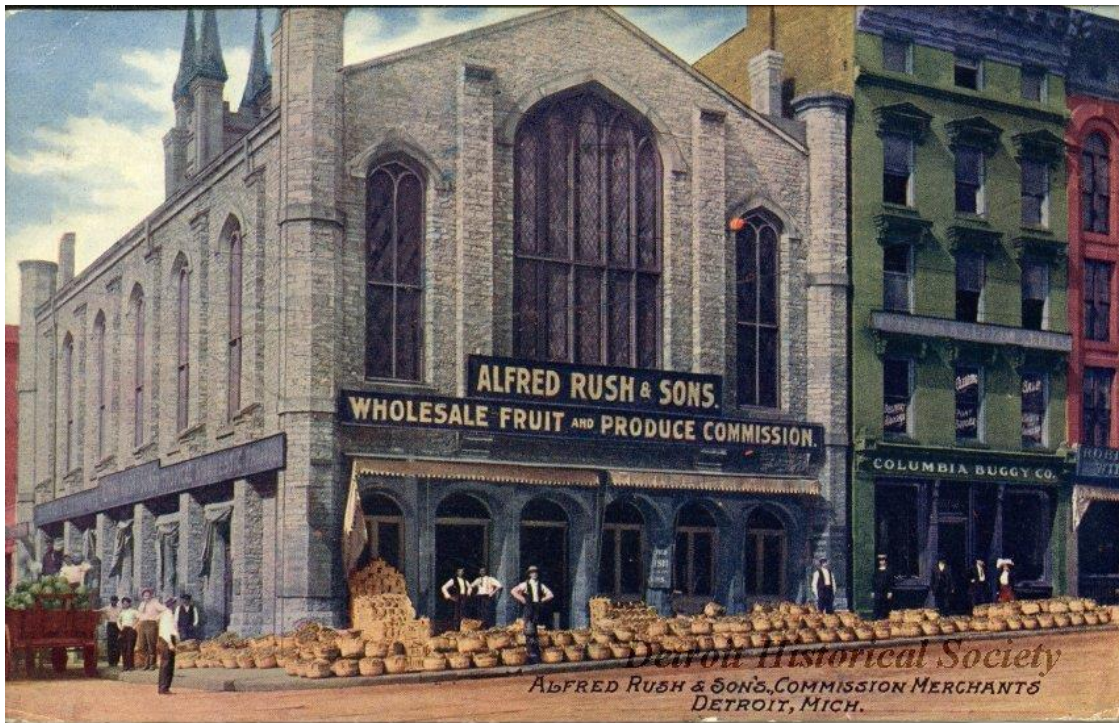

1910 Postcard Image of Previous Location – Detroit Historical Society

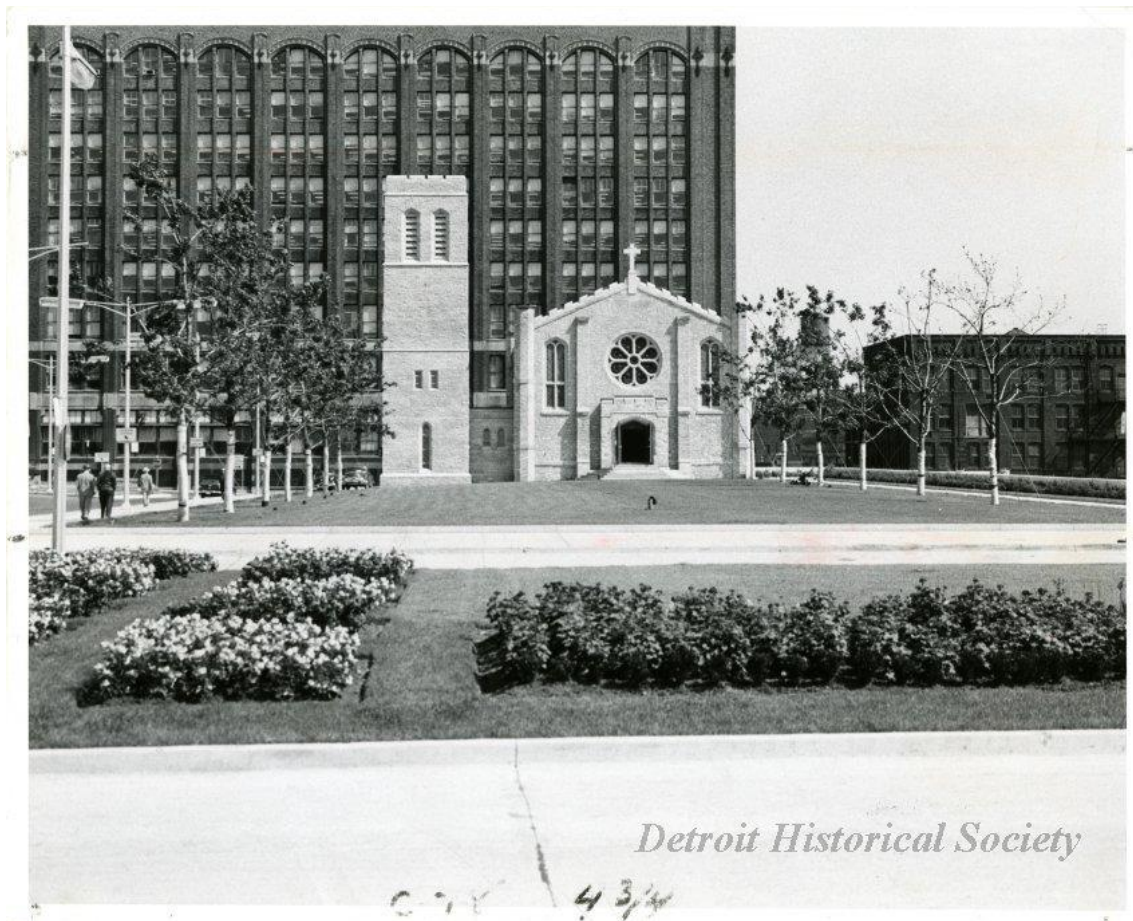

1960 Image of Current Location Looking East from Hart Plaza – Detroit Historical Society

Proposed Exterior Alterations:

1. Pinnacles. Reconstructing new pinnacles at the top of existing turrets located at each of the four corners of the building. Each of the four pinnacles would be approximately 18 feet tall and designed to mimic pinnacles that were previously present on the building as shown in a historic image provided on sheet A7 of the church’s Master Plan. Page notes indicate that the color and finish of the pinnacles would be to match existing stone coping, and dimensions and profiles would be to match historic drawings and photographs as best as possible.
2. Up-lighting. Focused up-lighting is proposed to highlight building architecture of all four facades, the tower, and the four reconstructed pinnacles. No lighting is proposed on the south façade wall facing the Detroit-Windsor Tunnel. Up-lighting is also proposed for the existing statue and flag located along East Jefferson Avenue that are separate from the building.
 - a. Section 50-14-418 states that all reasonable measures shall be taken to ensure that off-site spillover of light and nightglow are minimized to the greatest extent possible.
 - b. CPC staff finds that the revised Site Lighting plan dated July 28, 2022, would take reasonable measures to limit light spillover and nightglow as illuminance levels depicted on sheets A106, A108, and A110 indicate that the highest levels of illuminance would be focused on building facades, the tower, and pinnacles, and would not be focused off-site or directly into the sky. Additionally, there are numerous examples of buildings, especially churches, located within the Central Business District that have similar focused up-lighting provided.
3. Signage. Sometime during early-to-mid 2022, the existing readerboard type pole sign facing East Jefferson Avenue was removed from the site, see the below images for verification. It is our understanding that the church plans to replace this sign in the near future, potentially with

an upgraded digital sign similar to the removed sign. At this time, the applicant is not seeking approval of a replacement sign in order to proceed with more urgent building improvements, and the Master Plan indicates that the construction of any replacement sign in this location would be performed under a separate sign review and permit. Therefore, staff recommends that City Council delegate PC District review authority for any replacement sign to the City Planning Commission so that it can be reviewed administratively, along with the permitting authority BSEED. If City Council does not wish to delegate this authority to CPC, the applicant may pursue this replacement sign later as part of another PC District review.

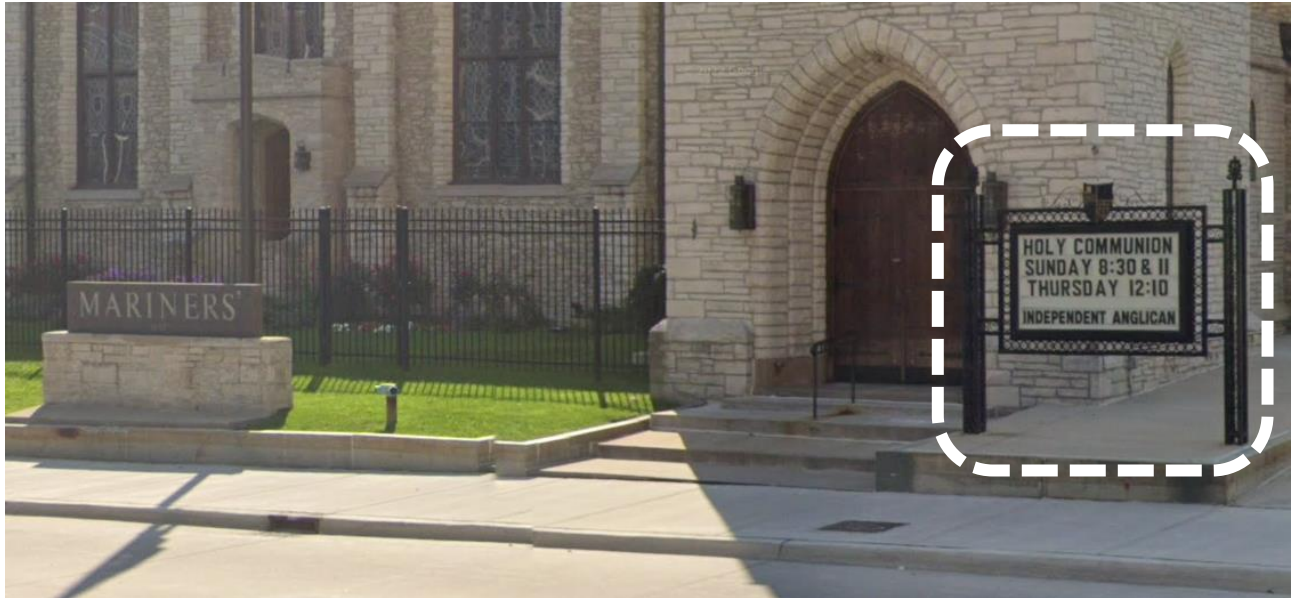

August 2021 Google Streetview of Removed Pole Sign

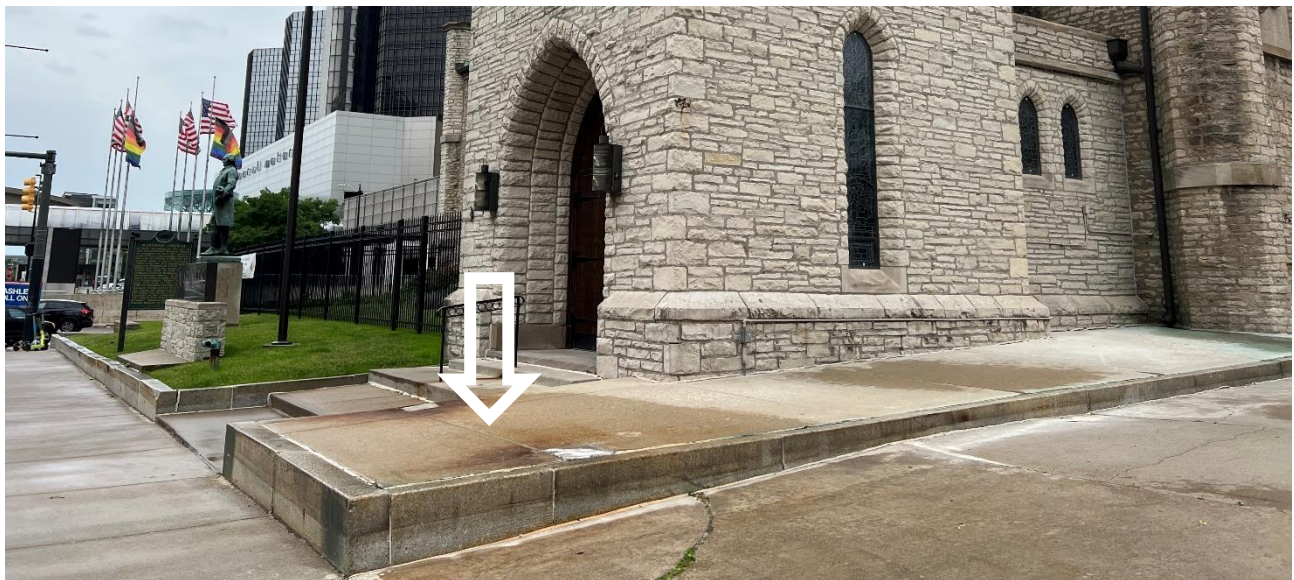

October 2022 Staff Photo of Removed Sign Location

4. Niches. Masonry infill in two locations on the west façade (facing Hart Plaza) is proposed to be removed at original building openings. A new glass fiber reinforced cast niche is proposed for the display of statues by the owner. Details of the statues were not provided.
5. Additional improvements include: relocating the existing historic marker facing East Jefferson Avenue to the northeast corner of the site, removal of existing foundation plantings along the north side of the building, removal of concrete near the sign that has been removed

and concrete leading to the south and west facades, the addition of decorative metal screens for existing air conditioner units, cleaning and tuckpointing maintenance of the existing partial height walls along the north and east façades, and maintenance of the stone coping along the east and west façade rooflines and also the existing Mariners’ stone sign to remain.

REVIEW & ANALYSIS

Nonconforming Uses

Mariners’ Church is considered a nonconforming use as “religious institutions”, which is the specific land use term for churches, are not permitted as a by-right or conditional use in the PC District. However, the proposed exterior alterations to the nonconforming church use do not fall under the requirements of Section 50-15-26, which requires a public hearing at the Board of Zoning Appeals for expansion or intensification of a nonconforming use. Specifically, Section 50-15-26(2) does not apply as there is no proposed change to the site plan involving a structure. Therefore, as the BZA is not “the body of first jurisdiction” for the PC District based on Section 50-3-225, staff finds that the current request may proceed with CPC review in accordance with Section 50-11-67 PC District review criteria.

PC District Review Criteria

There are eighteen PC District Review Criteria listed in Section 50-11-67 of the Zoning Ordinance. As stated in Section 50-3-225, the purpose of this design review “is to ensure harmony with the Public Center and for consistency with the spirit, intent, and purpose of the Zoning Ordinance.” Criteria that are most applicable to the proposed exterior alterations include:

(3) The proposed development should be compatible with surrounding development in terms of land use, general appearance and function and should not adversely affect the value of adjacent properties.

The proposed changes are minor and should not adversely affect adjacent properties.

(11) Signage and graphics should be tastefully designed to be visually appealing and in character with surrounding development; they should provide needed information, direction and orientation in a clear and concise manner.

Staff recommends that City Council delegate PC District review authority for any replacement sign to the City Planning Commission so that it can be reviewed administratively, along with the permitting authority BSEED. If City Council does not wish to delegate this authority to CPC, the applicant may pursue this replacement sign at a later date as part of another PC District review.

(13) Barrier-free access and public safety features should be carefully planned.

Existing barrier-free access to the church building south entrance would be maintained and does not appear to be impacted by the removal of small portions of concrete areas as these areas are not within the path of building entrances.

(14) Preservation/restoration of buildings having architectural or historic value should be considered a primary objective.

A primary objective of the proposal is to preserve and restore the existing building of high architectural and historic value.

(15) Urban design elements of form and character should be carefully considered; such elements include, but are not limited to: richness/interest of public areas through the provision of storefronts, window displays, landscaping, and artwork; color, texture and quality of structural materials; enclosure of public spaces; variations in scale; squares, plazas and/or “vest pocket parks” where appropriate; continuity of experience, visual activity and interest; articulation and highlighting important visual features; preservation/enhancement of important views and vistas.

The reconstruction of the historic building pinnacles and the addition of niches for sculptures would add important elements to the site that would improve building richness/interest of public areas adjacent to the site, improve visual activity and interest of the building, and the proposed up-lighting would address articulation and highlight important visual features of the building.

Design

The Planning & Development Department supports the requested improvements contained in the Mariner's Church Master Plan. The proposed changes and upgrades make the site more visually appealing and accentuate the unique character of the building through lighting, screening, and use of quality materials that should withstand deterioration over the years.

RECOMMENDATION

CPC staff recommends approval of the proposed exterior modifications to 170 East Jefferson Avenue as detailed in the attached Master Plan and with the following conditions:

1. That final site plans, elevations, landscape, and lighting plans be submitted for City Planning Commission staff approval prior to making application for applicable permits.
2. That City Council delegate PC review and approval authority of any future replacement sign as indicated in this report and the Master Plan to the City Planning Commission for review of a sign that complies with Chapter 4 of the 2019 Detroit City Code. City Planning Commission approval shall be required prior to BSEED granting a sign permit.
3. That written permission by the Michigan Historical Commission be obtained and submitted to BSEED for verification prior to removing and relocating the existing historic marker in accordance with Public Act 10 of 1955.

Respectfully submitted,



Marcell R. Todd, Jr., Director
Eric Fazzini, Staff

- Attachments:
1. Mariners' Church Master Plan dated 3/6/2023
 2. Mariners' Church Site Lighting dated 7/28/2022
 3. P&DD Recommendation Letter dated 6/9/2022
 4. Resolution

cc: Antoine Bryant, Director, PDD
Greg Moots, PDD
David Bell, Director, BSEED
Eric Johnson, BSEED
Conrad Mallett, Corp. Counsel, Law
Dan Arking, Law
Russell Beaver, RB Construction Company (applicant)
Thomas Roberts, AIA (architect)

**A RESOLUTION AUTHORIZING ALTERATIONS IN A PC ZONING DISTRICT
AT MARINERS' CHURCH, 170 EAST JEFFERSON AVE.**

BY COUNCIL MEMBER _____ :

WHEREAS, Mariners' Church proposes exterior alterations at 170 East Jefferson Avenue; and

WHEREAS, Mariners' Church at 170 East Jefferson Avenue is located within an established PC (Public Center) zoning district; and

WHEREAS, work to be performed within a PC zoning district requires Special District Review and the purpose of the PC zoning district classification is provided for in Section 50-11-51 of the Zoning Ordinance as follows:

The PC Public Center District includes areas used or to be used for governmental, recreational, and cultural purposes of particular or special civic importance. All construction or other improvement within this district requires that the Planning and Development Department and the City Planning Commission review and make recommendation to City Council, as provided for in Article III, Division 6, of this chapter so as to ensure a completely harmonious, pleasing, and functional public center; and

WHEREAS, the City Council has received the CPC staff recommendation and concurrent support of the Planning and Development Department in the CPC report dated March 8, 2023.

NOW, THEREFORE, BE IT RESOLVED, that the Detroit City Council hereby approves the proposed exterior alterations depicted in drawings prepared by Thomas Roberts Architect and dated 3/6/2023 (Master Plan) and dated 7/28/2022 (Site Lighting), referenced in the staff report, with the following conditions:

1. That final site plans, elevations, landscape, and lighting plans be submitted for City Planning Commission staff approval prior to making application for applicable permits.
2. That City Council delegate PC review and approval authority of any future replacement sign as indicated in this report and the Master Plan to the City Planning Commission for review of a sign that complies with Chapter 4 of the 2019 Detroit City Code. City Planning Commission approval shall be required prior to BSEED granting a sign permit.
3. That written permission by the Michigan Historical Commission be obtained and submitted to BSEED for verification prior to removing and relocating the existing historic marker in accordance with Public Act 10 of 1955.



**PLANNING AND
DEVELOPMENT DEPARTMENT**

Coleman A. Young Municipal Center
2 Woodward Avenue, Suite 808
Detroit, Michigan 48226

Phone 313•224•1339
www.detroitmi.gov

Marcell R. Todd Jr., Director
Detroit City Planning Commission
208 CAYMC
Detroit, MI 48226

June 9, 2022

Dear Director Todd:

Following is the review by the Planning and Development Department (PDD) of the Mariner's Church Master Plan for 170 E Jefferson Ave. (BSEED Permit number BLD2022-02014). The church was listed on the National Register of Historic of Historic Places in 1971. As the property is zoned PC (Public Center), this review is required under Sec. 50-11-96 of the City of Detroit Zoning Ordinance.

The relevant PC criteria from Sec. 50-11-67 of the Zoning Ordinance are followed by our analysis in italics:

Criterion 9: Appropriate buffering and screening of service, loading, refuse collection, mechanical and electrical equipment and parking areas should be provided; *Decorative metal screening of air conditioning units will create a more visually appealing treatment for service equipment. New trench drains and grate covers in existing sidewalk in the rear of building will provide for better drainage that is less intrusive for pedestrian traffic.*

Criterion 11: Signage and Graphics should be tastefully designed to be visually appealing and in character with surrounding development, they should provide needed information, direction and orientation in a clear and concise manner; *Relocation and 90 degree rotation of the sign, converting to a 2' X 5' double-sided digital display along Jefferson Ave. (north elevation) and restoring the grass under the relocated sign on the north elevation, relocating sign on the south elevation adjacent to entrance doors will be more accessible by pedestrians while still visible to vehicular traffic.*

Criterion 14 Preservation/restoration of buildings having architectural or historic value should be considered a primary objective; *Relocating of Historic marker to the corner on the west elevation tuckpointing of masonry walls, drainage updates, up lighting to bring attention to architectural detail of the north, east and west elevations building, removal of light pole on the west elevation, restoration of pinnacles on all elevations of the building by matching historical precedent, modifying niches for the display of statues on the west elevation by removing masonry infill, and appears appropriate.*

Criterion 15: Urban design elements of form and character should be carefully considered; such elements include, but are not limited to: richness/ interest of public areas through the provision of storefronts, window displays, landscaping, and artwork; color, texture and quality of structural

materials; enclosure of public spaces; variations in scale; squares, plazas and/or "vest pocket parks" where appropriate; continuity of experience, visual activity and interest; articulation and highlighting of important visual features; preservation/enhancement of important views and vistas; *Use of like colors and materials for the replacement of stone coping and sealant should retain the existing visual character of the building. Replacement of cement with grass and planting beds surrounding both signs on the south elevation provide visual interest and less hardscape for pedestrian foot-traffic.*

PDD supports the requested improvements contained in the Mariner's Church Master Plan. The Master plan has included appropriate materials and new sign technology within a historic context. The proposed changes and upgrades make the site more visually appealing and accentuate the unique character of the building through lighting, screening and use of quality materials that should withstand deterioration over the years.

Our support of the double-sided digital display along Jefferson Ave. is contingent upon the sign meeting all Federal, State, and City regulations. We conclude that the proposed sign will not significantly negatively impact the character of the surrounding downtown area adjacent to the Public Center.

Respectfully submitted,

A handwritten signature in blue ink that reads "Gregory Moots". The signature is fluid and cursive, with the first name being the most prominent.

Gregory Moots
Lead Planner-Design and Developer Innovation
Planning and Development Department

CC: Karen Gage
Russell Baltimore



MASTER PLAN

for
MARINERS' CHURCH OF DETROIT
170 E JEFFERSON AVE, DETROIT, MI 48226

March 6, 2023

<p><u>GENERAL NOTES</u></p> <p>A. THIS MASTER PLAN DOCUMENT OUTLINES THE OWNER'S INTENT FOR DESIGN AND PERFORMANCE. WHILE IT MAY BE USED FOR THE PURPOSE OF A CONTRACTOR'S ORDER OF MAGNITUDE COST ESTIMATE, THIS DOCUMENT SHALL NOT BE USED FOR PERMITS AND / OR CONSTRUCTION.</p> <p>B. THE SPECIFIC SCOPE OF WORK WILL BE DETERMINED AND PROVIDED AT A LATER DATE; INCLUDING DIMENSIONS, DETAILS, SCHEDULES, ETC.</p> <p>C. THE MEANS AND METHODS OF CONSTRUCTION ARE THE RESPONSIBILITY OF THE CONTRACTOR; INCLUDING BUT NOT LIMITED TO POWER AND LIGHTING ELECTRICAL SERVICE AND CIRCUITING.</p>	<p><u>REVIEWING AGENCIES:</u> CITY OF DETROIT BUILDING AND SAFETY</p> <p><u>REFERENCED CODES/ORDINANCES:</u> BUILDING: 2015 MICHIGAN REHABILITATION CODE FOR EXISTING BUILDINGS 2015 MICHIGAN BUILDING CODE MECHANICAL: 2015 MICHIGAN MECHANICAL CODE PLUMBING: 2018 MICHIGAN PLUMBING CODE ELECTRICAL: 2017 NATIONAL ELECTRICAL CODE LIFE SAFETY & FIRE: 2015 MICHIGAN BUILDING CODE 2015 NFPA 101 LIFE SAFETY CODE BARRIER FREE: ICC/ANSI A117.1 (2009) ZONING ORDINANCE: CITY OF DETROIT</p>
---	---

Owner: Mariners' Church of Detroit
170 E. Jefferson Ave.
Detroit, MI 48226
313.259.2206

Architect: Thomas Roberts Architect
2927 4th Street
Wyandotte, MI 48192
734.250.4032

Sheet Index:	----	Cover
	A1	Site Plan
	A2	North Elevation
	A3	East Elevation
	A4	South Elevation
	A5	West Elevation
	A6	Details
	A7	Details
	A8	Details
	A9	Details

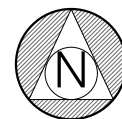
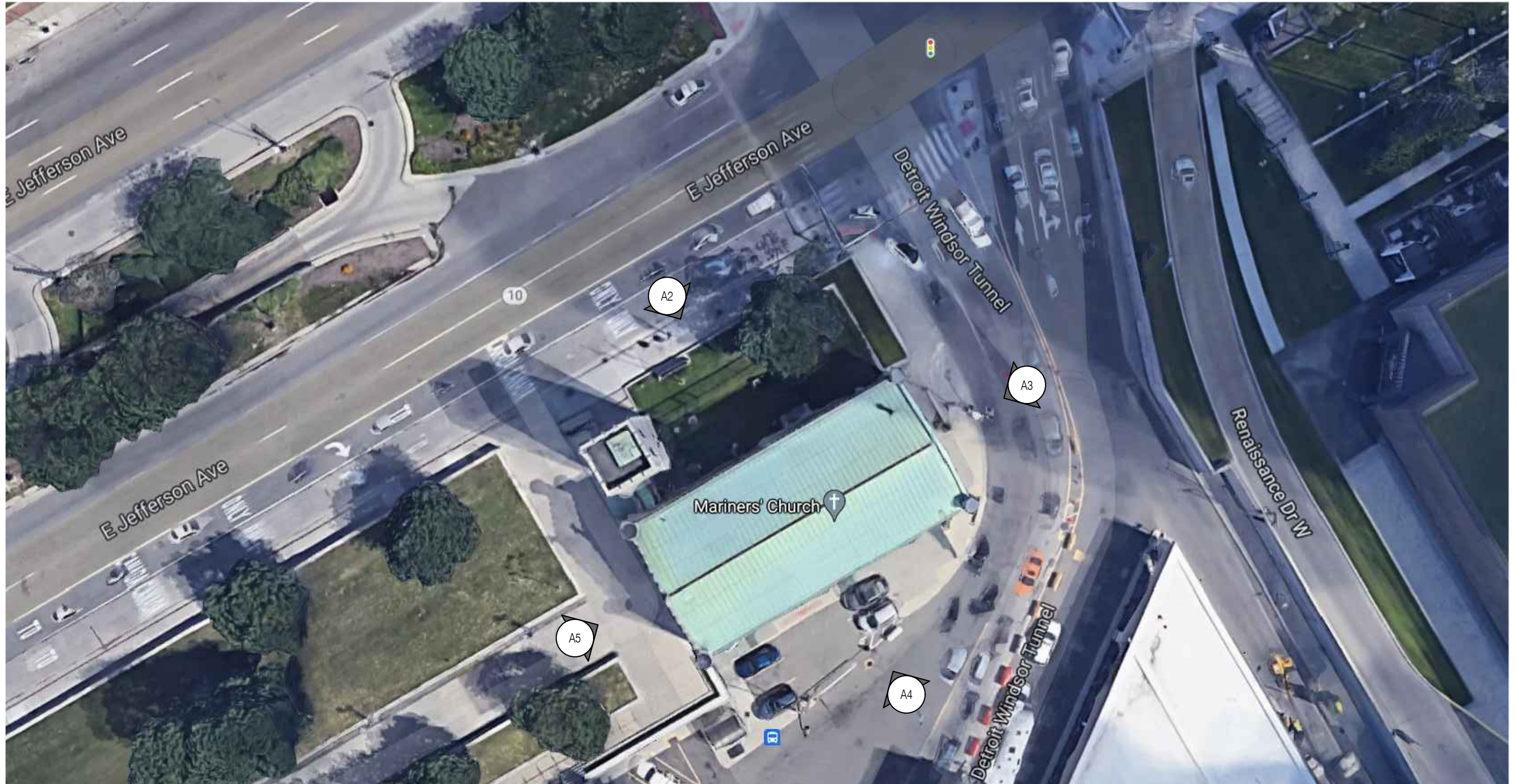

TRUE
NORTH

SITE PLAN



PROJECT
NORTH

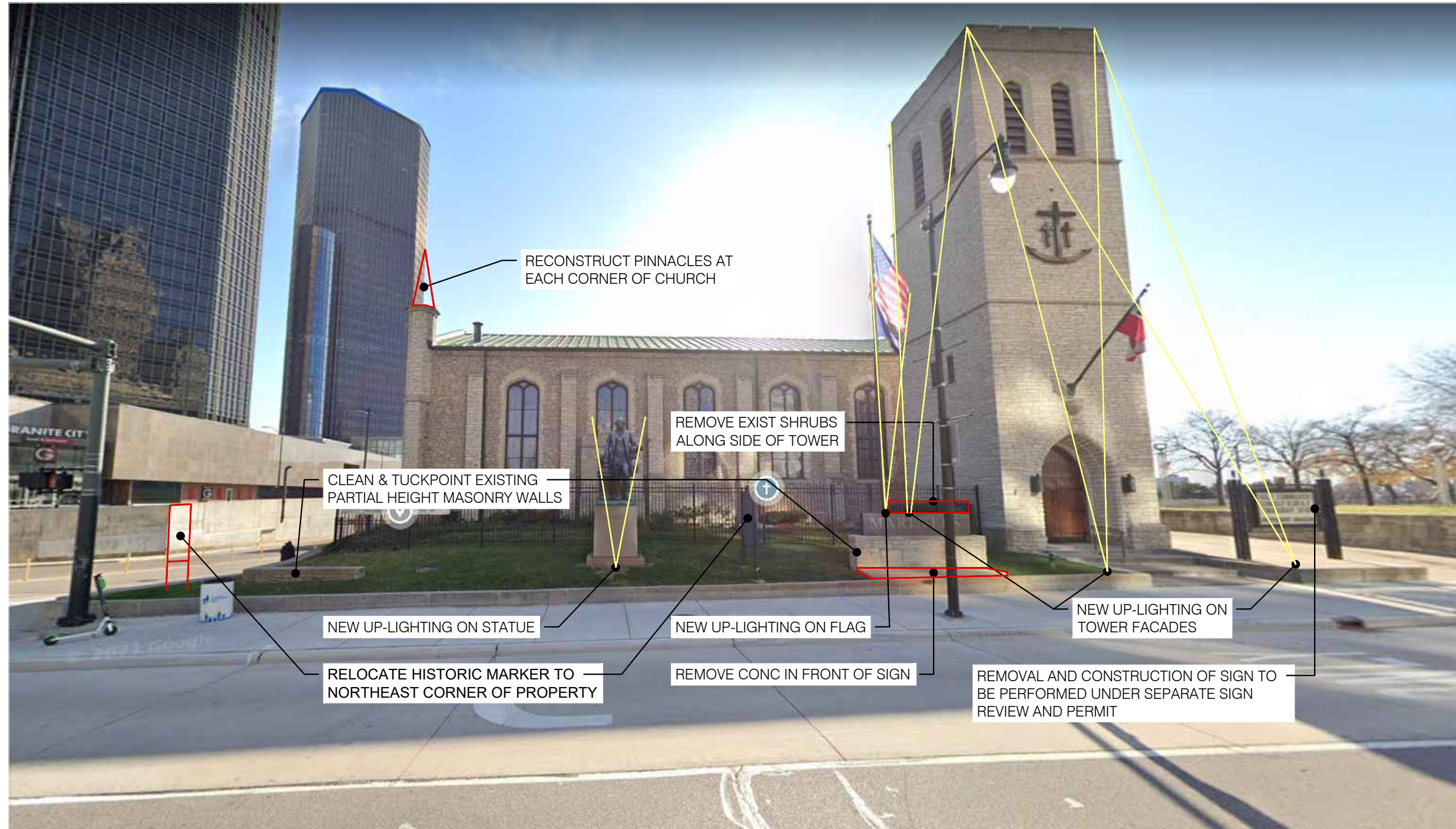

NORTH ELEVATION

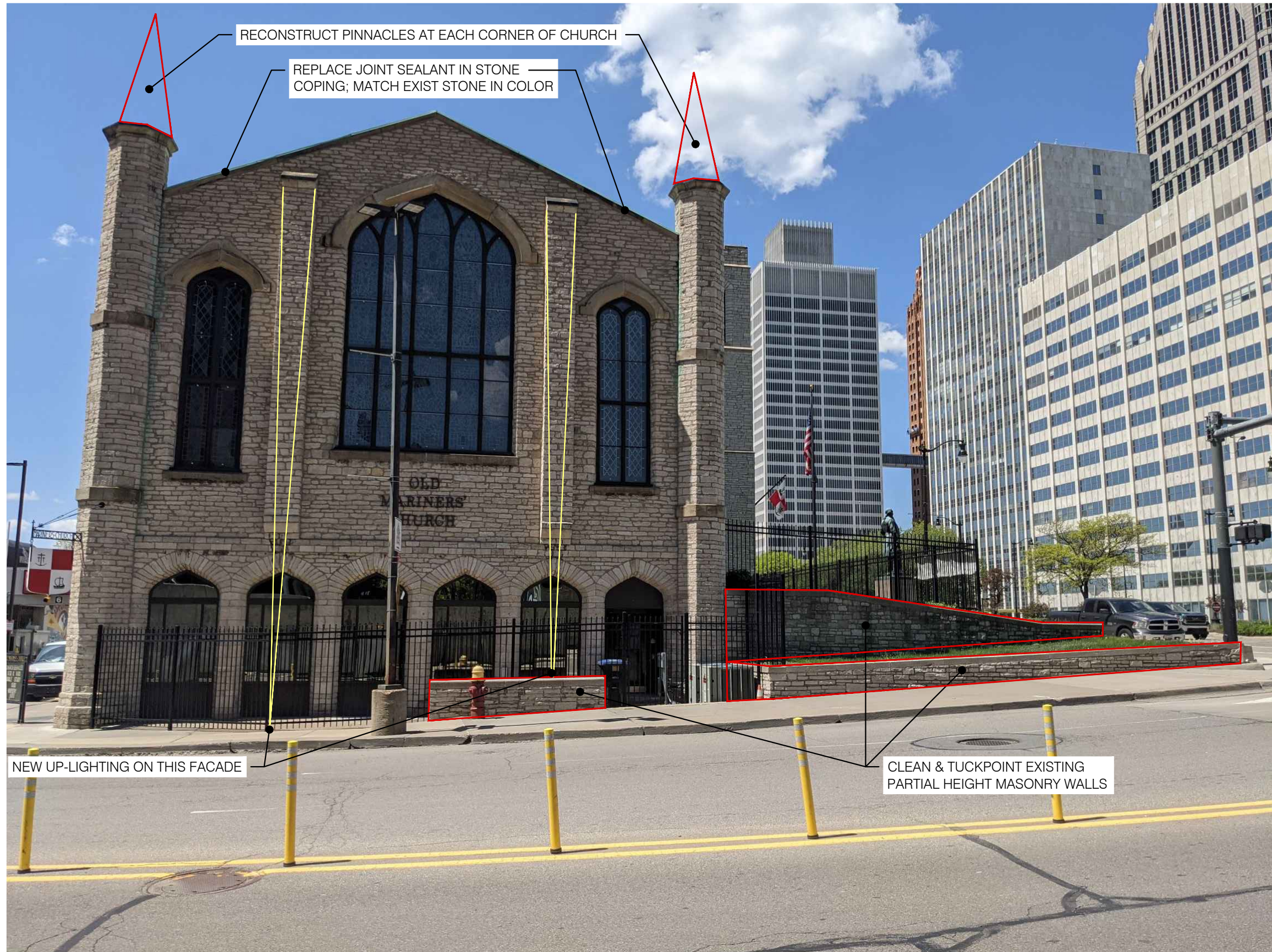

EAST ELEVATION

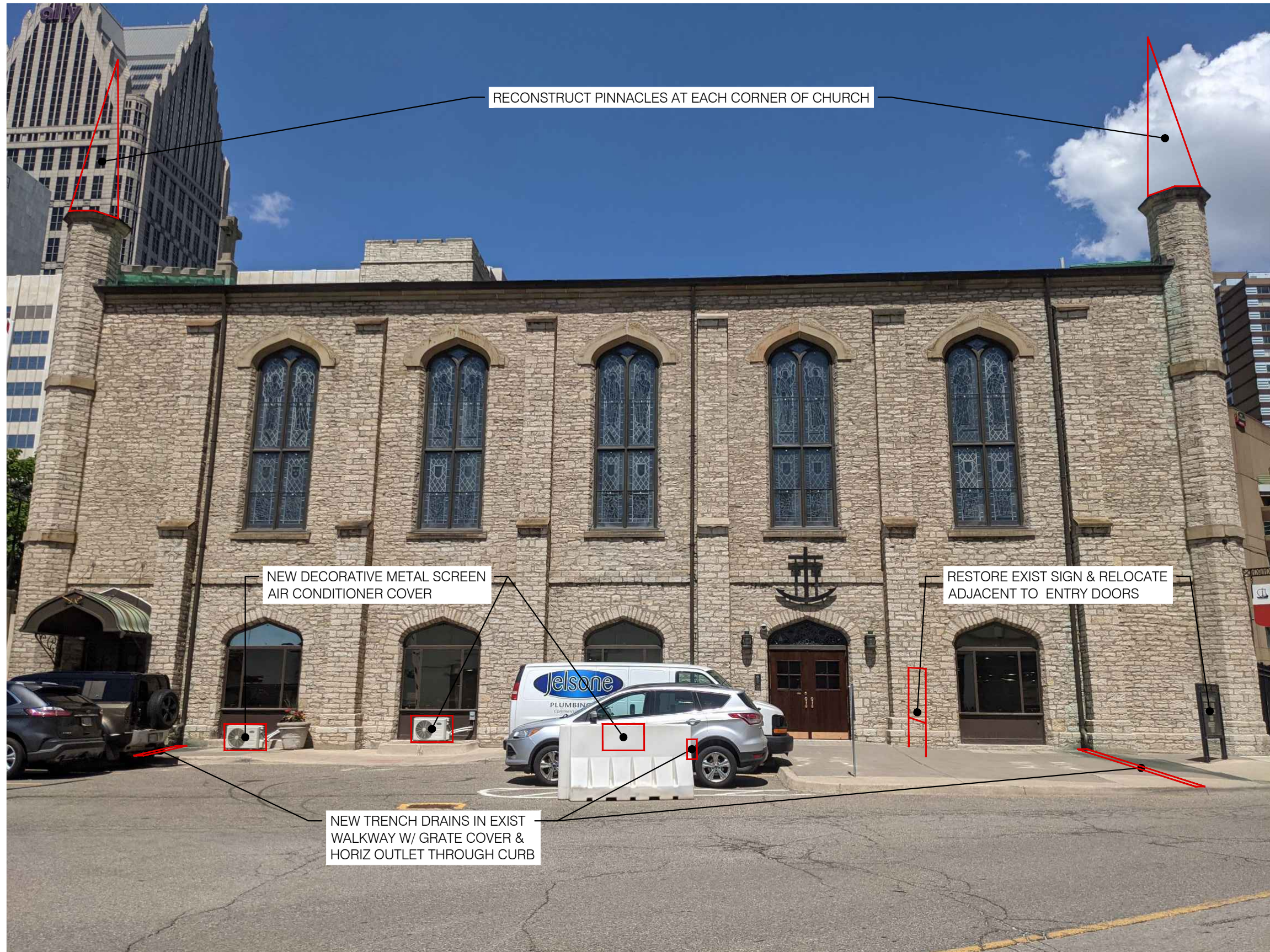

SOUTH ELEVATION

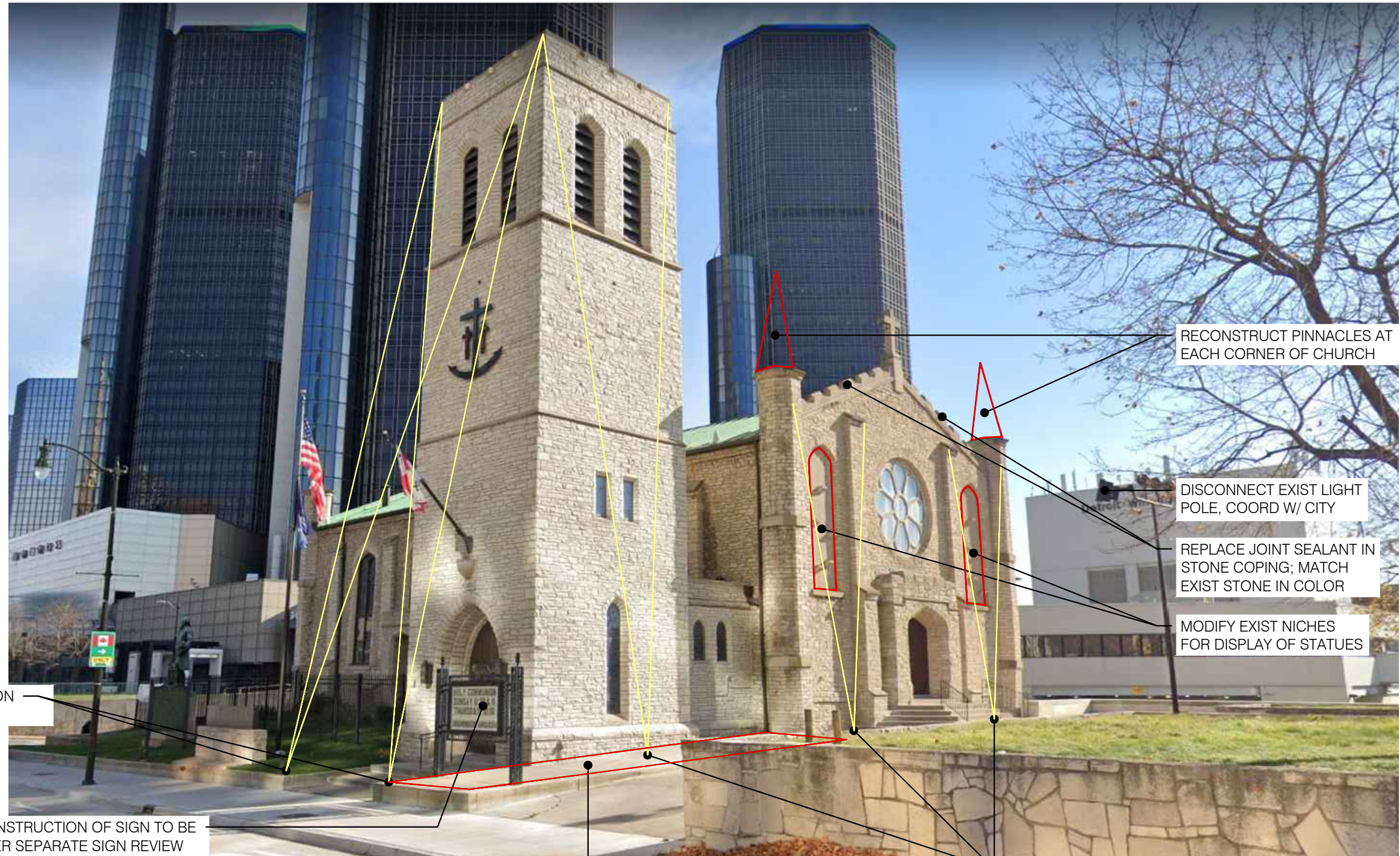

NEW UP-LIGHTING ON THIS FACADES

REMOVAL AND CONSTRUCTION OF SIGN TO BE PERFORMED UNDER SEPARATE SIGN REVIEW AND PERMIT

REMOVE CONC AND REPLACE W/ LAWN BETWEEN ENTRY STEPS AND DRIVEWAY; EXISTING CURB TO REMAIN

RECONSTRUCT PINNACLES AT EACH CORNER OF CHURCH

DISCONNECT EXIST LIGHT POLE, COORD W/ CITY

REPLACE JOINT SEALANT IN STONE COPING; MATCH EXIST STONE IN COLOR

MODIFY EXIST NICHES FOR DISPLAY OF STATUES

NEW UP-LIGHTING ON THIS FACADE

WEST ELEVATION

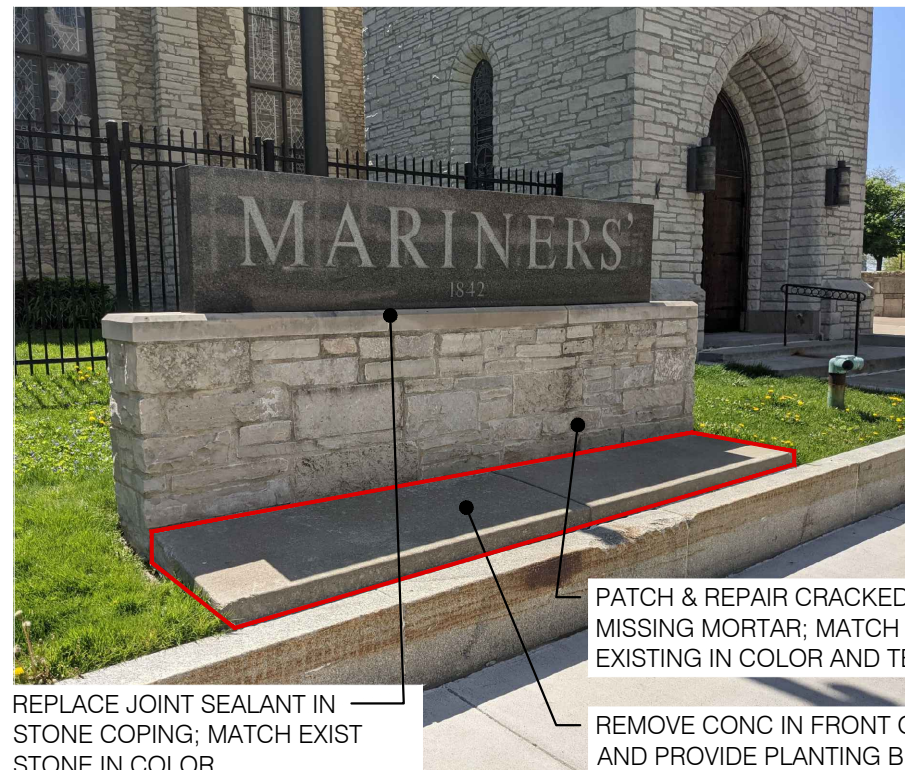

REPLACE JOINT SEALANT IN STONE COPING; MATCH EXIST STONE IN COLOR

PATCH & REPAIR CRACKED OR MISSING MORTAR; MATCH EXISTING IN COLOR AND TEXTURE

REMOVE CONC IN FRONT OF SIGN AND PROVIDE PLANTING BED

REMOVAL AND CONSTRUCTION OF SIGN TO BE PERFORMED UNDER SEPARATE SIGN REVIEW AND PERMIT



NEW UP-LIGHTING ON TOWER FACADES

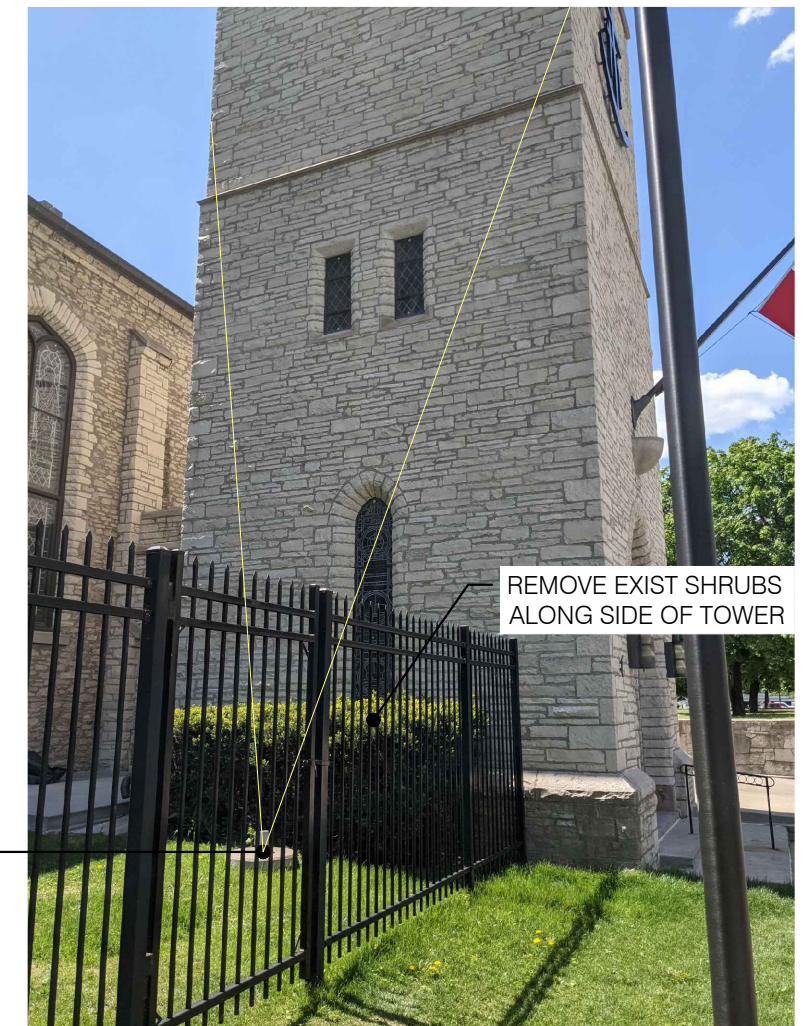

REMOVE EXIST SHRUBS ALONG SIDE OF TOWER

DETAILS



PRODUCTS:

PINNACLES: PROP ART INC. OR EQUAL

- ALUMINUM OR STEEL INTERIOR SQUARE BOX TRUSS FRAMING WITH ONE-PIECE PICK POINT AT TOP
- ANCHORING HARDWARE TBD
- SCULPTED 6 LB. DENSITY URETHANE BOARD ATTACHED TO BOX FRAME; SEALED AND SANDED SEAMS, JOINTS, AND GAPS
- ACCESS PANEL AT BASE
- SPRAY APPLIED URETHANE PLASTIC HARD COAT; COLOR AND FINISH TO MATCH EXISTING STONE COPING
- AUTOMOTIVE GRADE CLEAR URETHANE TOP COAT
- DIMENSIONS AND PROFILES TO MATCH HISTORIC DRAWINGS AND PHOTOGRAPHS AS BEST POSSIBLE

LUMINAIRES: LUMENPULSE LUMENBEAM MEDIUM/GRANDE

- MEDIUM 28W FIXTURE FOR COLUMNS, TREES OR OTHER ARCHITECTURAL AND LANDSCAPE FEATURES
- GRANDE 100W FIXTURE FOR ARCHITECTURAL EXTERIORS AND FACADES
- OPTIONS FOR FLOOD OR ACCENT LIGHTING; COLOR TEMPERATURES AND COLORS; MOUNTING; ACCESSORIES; SPREAD LENSES; AND CONTROLS.

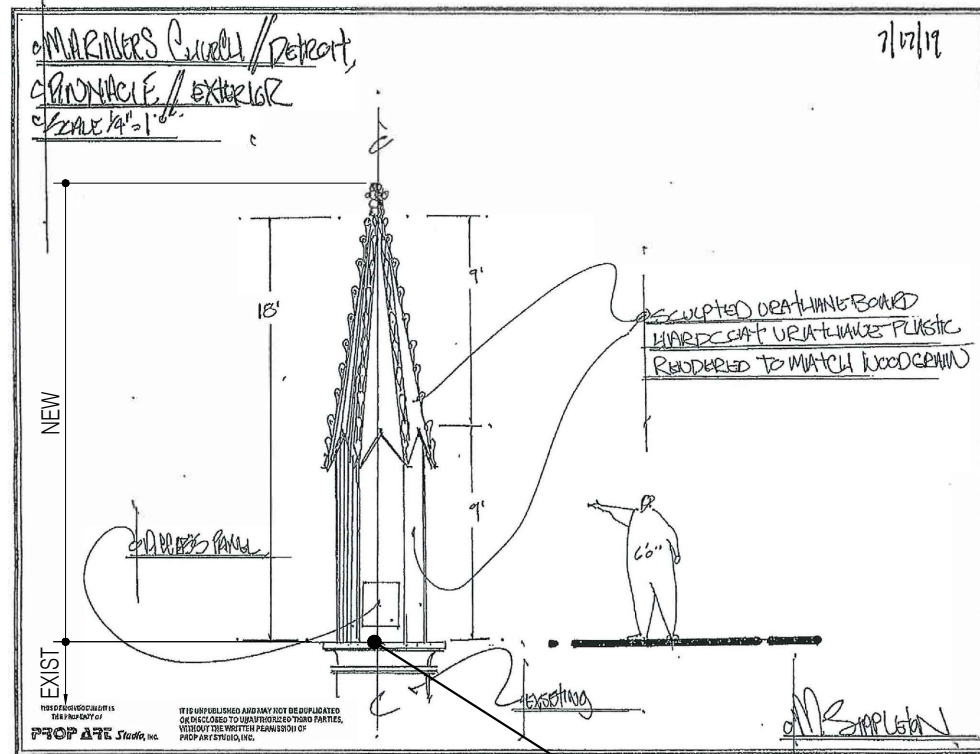

RECONSTRUCT NEW PINNACLES ON EXISTING TURRETS AT EACH OF 4 CORNERS OF THE CHURCH

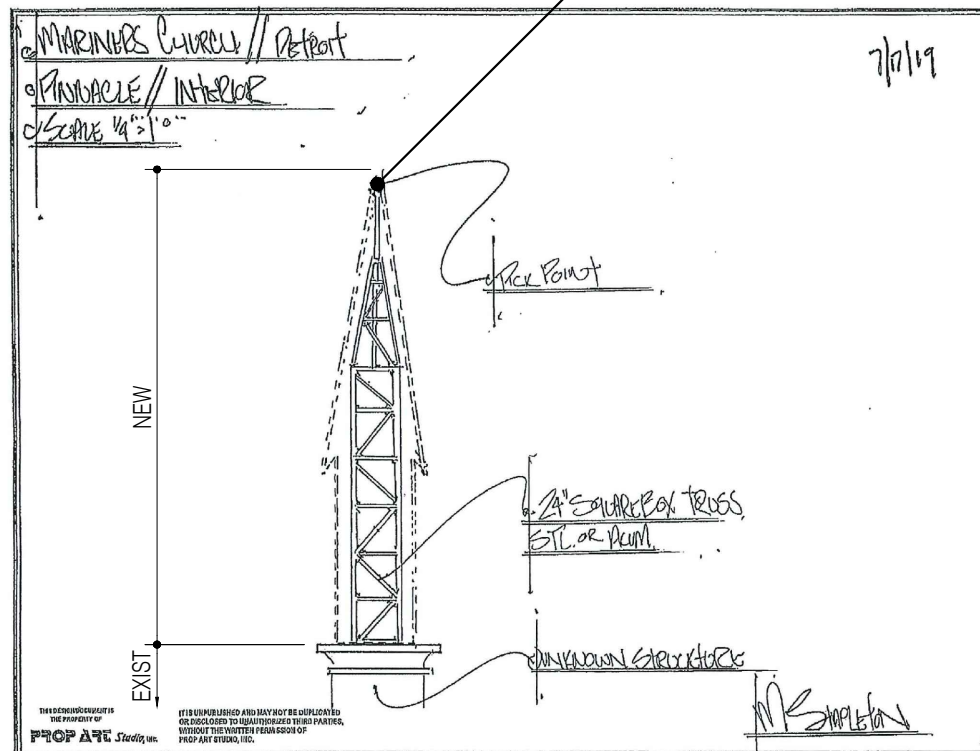

REPLACE JOINT SEALANT IN STONE COPING; MATCH EXISTING STONE IN COLOR

PATCH & REPAIR CRACKED OR MISSING MORTAR; MATCH EXISTING IN COLOR AND TEXTURE

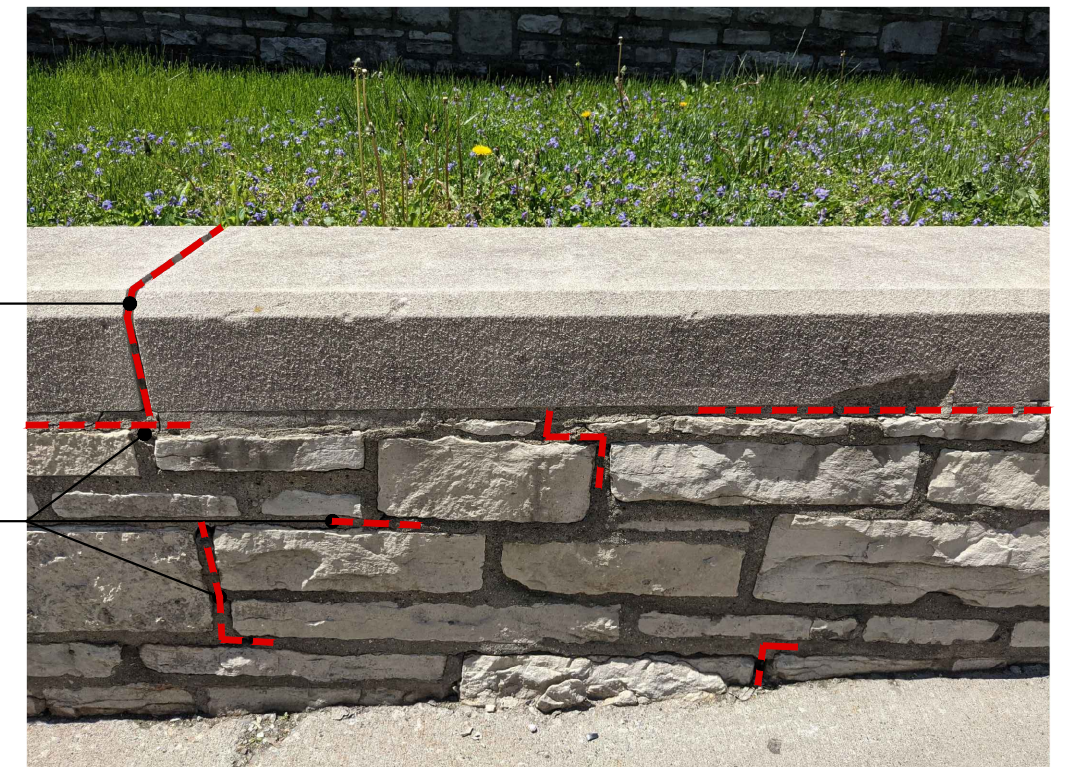

DETAILS



PRODUCTS:

- TRENCH DRAIN: ABT, INC. POLYDRAIN OR EQUAL
- MODULAR PRE-ENGINEERED, PRE-SLOPED 4" CHANNEL MADE FROM POLYMER CONCRETE
 - ENDPLATES WITH HORIZONTAL OUTLET THROUGH CURB
 - ORNAMENTAL DUCTILE IRON SLOTTED GRATING WITH LOCKS

- AIR CONDITIONER COVER: TITAN CUT L.L.C. OR EQUAL
- LASER CUT METAL SCREEN PANELS CUSTOM MADE TO ORDER AS 5-SIDED COVER
 - 14 GA. MILD STEEL OR ALUMINUM
 - POWDERCOAT FINISH IN STANDARD COLOR

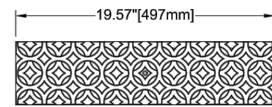

Decorative Pattern: Imperial Star

GRATE TOP VIEW
(ROTATED 90°)

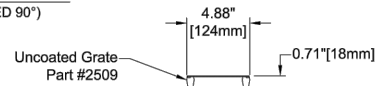

Uncoated Grate
Part #2509

GRATE END VIEW

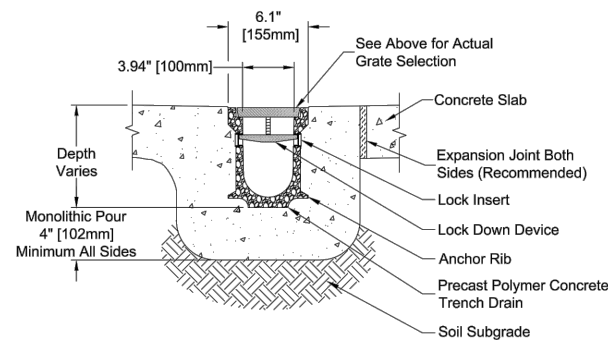

END CROSS SECTION VIEW

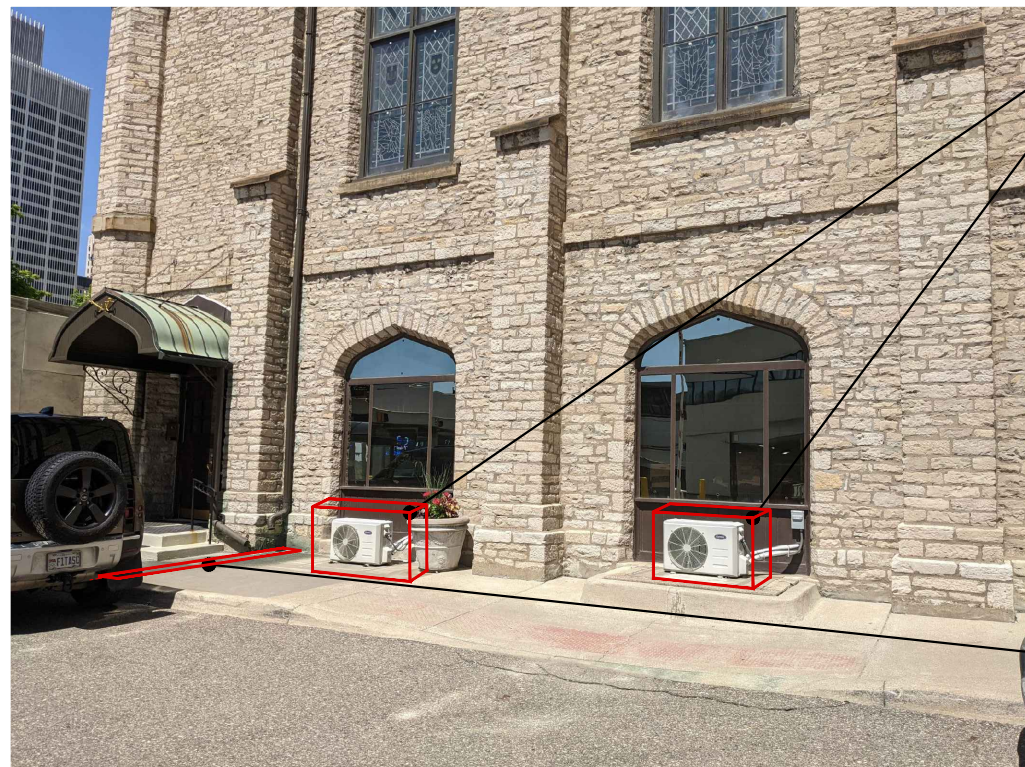

(3) NEW DECORATIVE METAL SCREEN AIR CONDITIONER COVERS WITH LOCKABLE ACCESS PANEL FOR MAINTENANCE

SAW CUT EXISTING WALKWAY AND PROVIDE (3) NEW TRENCH DRAINS W/ GRATE COVER & HORIZ OUTLET THROUGH CURB

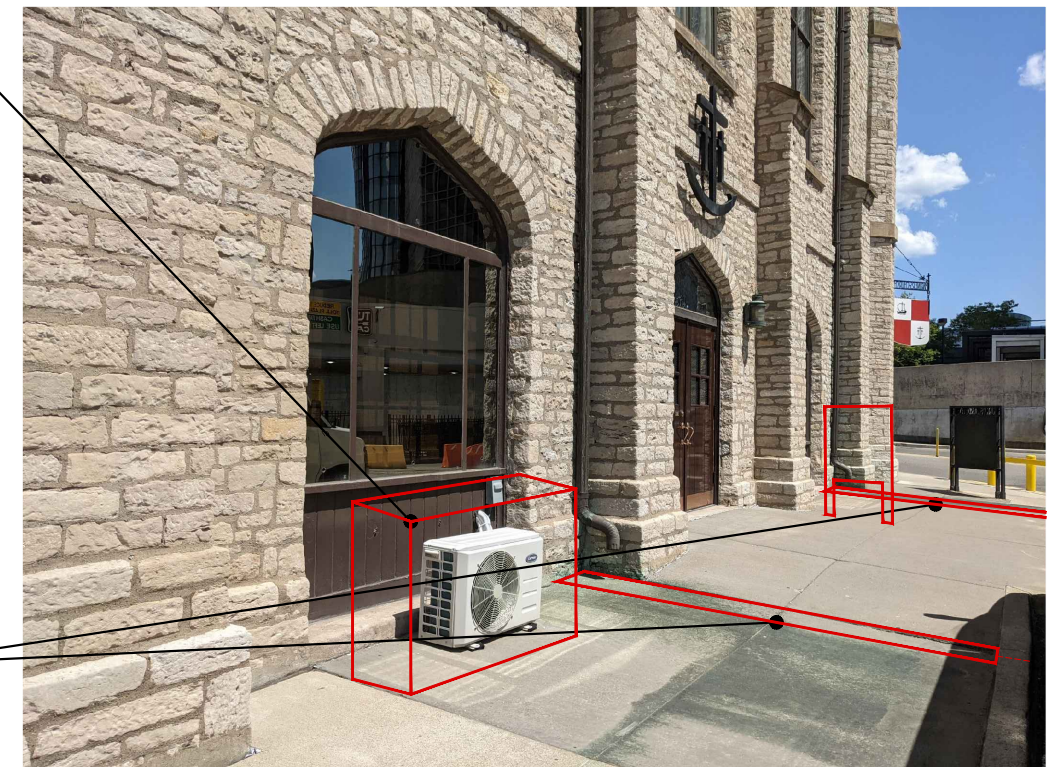

DETAILS



PRODUCTS:

- NICHES: STROMBERG ARCHITECTURAL OR EQUAL
- GLASS FIBER REINFORCED STONE (GFRS): CRUSHED STONE AND RESIN WITH ALKALI RESISTANT GLASS FIBERS MIXED AND SPRAYED INTO A MOLD
 - CUSTOM DESIGN: ORNATE CURVES, SCROLLED EDGES AND DESIGNS THAT COMPLEMENT OTHER ARCHITECTURAL ELEMENTS LIKE ENTRYWAYS OR MEDALLIONS
 - FINAL PRODUCT HAS THE LOOK OF TRADITIONAL HEAVY STONEWORK BUT AT A FRACTION OF THE WEIGHT

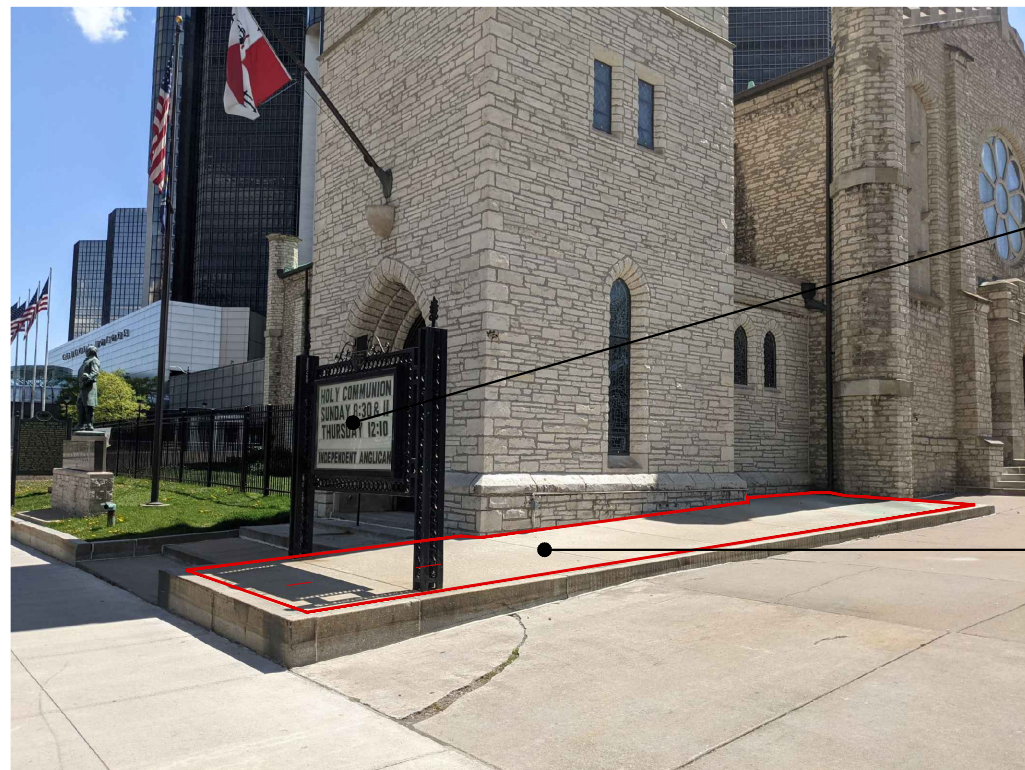

REMOVAL AND CONSTRUCTION OF SIGN TO BE PERFORMED UNDER SEPARATE SIGN REVIEW AND PERMIT

REMOVE CONC AND REPLACE W/ LAWN BETWEEN ENTRY STEPS / BUILDING AND DRIVEWAY; WATERPROOF BUILDING FOUNDATION BELOW GRADE EXPOSED DURING CONSTRUCTION

REMOVE EXIST MASONRY INFILL AT ORIGINAL OPENING; INSERT NEW GLASS FIBER REINFORCED CAST NICHE FOR DISPLAY OF STATUES BY OWNER

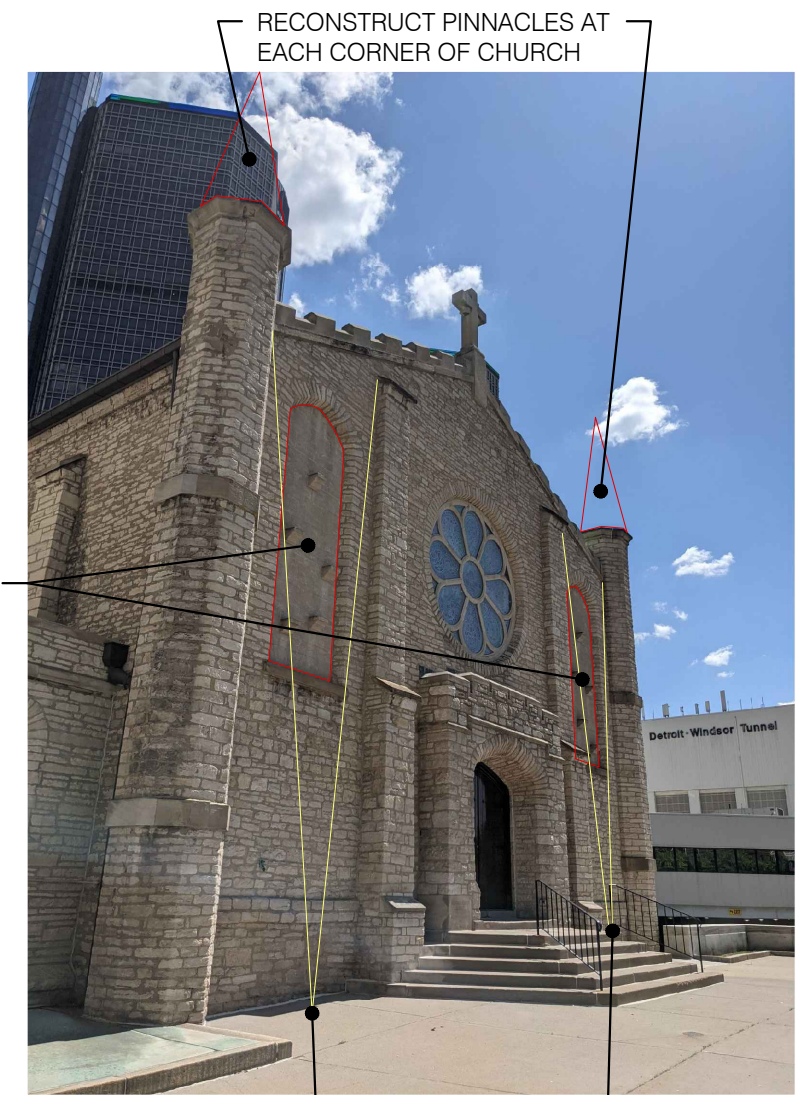

RECONSTRUCT PINNACLES AT EACH CORNER OF CHURCH

NEW UP-LIGHTING ON THIS FACADE

DETAILS

MARINER'S CHURCH OF DETROIT

Site Lighting

170 E. Jefferson Ave. Detroit, MI 48226

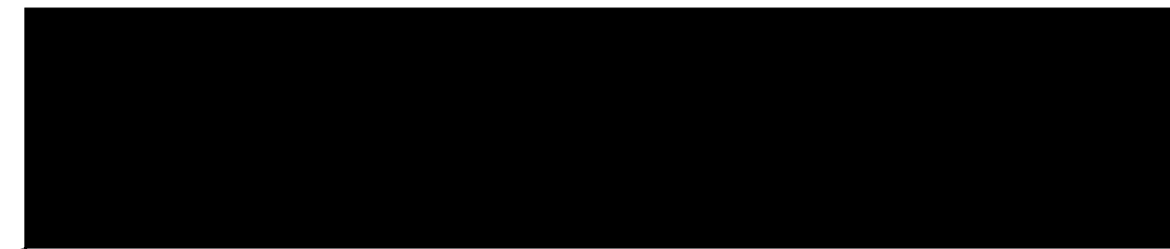

owner
MARINERS CHURCH OF DETROIT
170 E. Jefferson Ave.
Detroit, MI 48226
313.259.2206 (t)

architect
THOMAS ROBERTS ARCHITECT, LLC
2927 4th Street
Wyandotte, MI 48192
734.250.4032 (t)

general contractor
RB CONSTRUCTION COMPANY
249 Cass Avenue
Mount Clemens, MI 48043
586.264.9478 (t)

Drawing Index

----	Cover Sheet
A101	Lighting Plan
A102	West Elevation
A103	East Elevation
A104	North Elevation
A105	West Isometric Contrast
A106	West Isometric Illuminance
A107	North Isometric Contrast
A108	North Isometric Illuminance
A109	East Isometric Contrast
A110	East Isometric Illuminance
A111	North Isometric Contrast
A112	North Isometric Illuminance
A113	Specification Sheets



 Location Map

July 28th, 2022

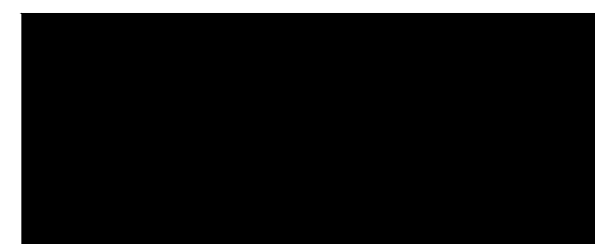

22010 Permits

